

DATASHEET



NI 9775

4-Ch, ± 10 V, 20 MS/s, 14-Bit Digitizer



- BNC connectivity
- High-speed measurements up to 20 MS/s/ch at 68 dB SNR
- High-resolution measurements up to 5 MS/s/ch at 74 dB SNR
- 14-bit resolution
- Built-in analog reference trigger
- 128 Mbits onboard memory

The NI 9775, a 4-channel digitizer, can measure transient phenomenon like faults in electrical transmission lines from lightning strikes or structural failure events at 20 MS/s/ch. The module's store and forward architecture allows up to 128 Mbits of measurement data to be sent back to the controller and analyzed. The module has a built-in analog reference trigger, or you can use CompactRIO and LabVIEW FPGA to develop an advanced trigger based on low-speed streaming data for added flexibility.

	Kit Contents	<ul style="list-style-type: none">• NI 9775• NI 9775 Getting Started Guide
	Accessories	<ul style="list-style-type: none">• BNC Male to BNC Male Cables

NI C Series Overview



NI provides more than 100 C Series modules for measurement, control, and communication applications. C Series modules can connect to any sensor or bus and allow for high-accuracy measurements that meet the demands of advanced data acquisition and control applications.

- Measurement-specific signal conditioning that connects to an array of sensors and signals
- Isolation options such as bank-to-bank, channel-to-channel, and channel-to-earth ground
- -40 °C to 70 °C temperature range to meet a variety of application and environmental needs
- Hot-swappable

The majority of C Series modules are supported in both CompactRIO and CompactDAQ platforms and you can move modules from one platform to the other with no modification.

CompactRIO



CompactRIO combines an open-embedded architecture with small size, extreme ruggedness, and C Series modules in a platform powered by the NI LabVIEW reconfigurable I/O (RIO) architecture. Each system contains an FPGA for custom timing, triggering, and processing with a wide array of available modular I/O to meet any embedded application requirement.

CompactDAQ

CompactDAQ is a portable, rugged data acquisition platform that integrates connectivity, data acquisition, and signal conditioning into modular I/O for directly interfacing to any sensor or signal. Using CompactDAQ with LabVIEW, you can easily customize how you acquire, analyze, visualize, and manage your measurement data.



Software

LabVIEW Professional Development System for Windows

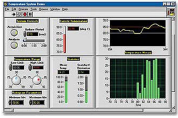

- Use advanced software tools for large project development
- Generate code automatically using DAQ Assistant and Instrument I/O Assistant
- Use advanced measurement analysis and digital signal processing
- Take advantage of open connectivity with DLLs, ActiveX, and .NET objects
- Build DLLs, executables, and MSI installers

NI LabVIEW FPGA Module

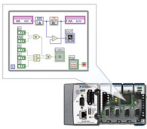

- Design FPGA applications for NI RIO hardware
- Program with the same graphical environment used for desktop and real-time applications
- Execute control algorithms with loop rates up to 300 MHz
- Implement custom timing and triggering logic, digital protocols, and DSP algorithms
- Incorporate existing HDL code and third-party IP including Xilinx IP generator functions
- Purchase as part of the LabVIEW Embedded Control and Monitoring Suite

NI LabVIEW Real-Time Module

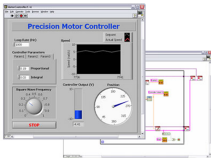

- Design deterministic real-time applications with LabVIEW graphical programming
- Download to dedicated NI or third-party hardware for reliable execution and a wide selection of I/O
- Take advantage of built-in PID control, signal processing, and analysis functions
- Automatically take advantage of multicore CPUs or set processor affinity manually
- Take advantage of real-time OS, development and debugging support, and board support
- Purchase individually or as part of a LabVIEW suite

Circuitry

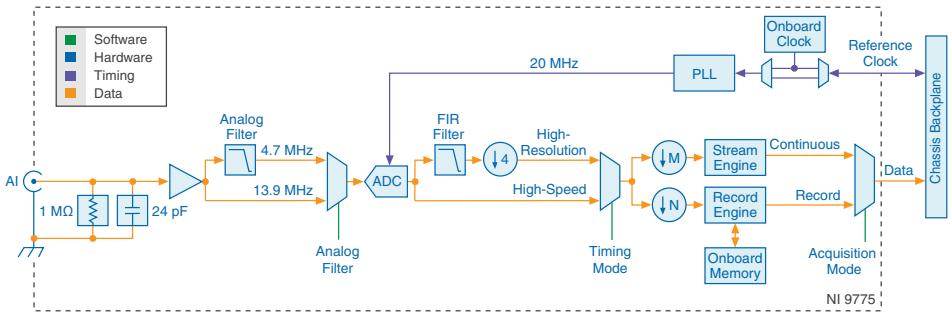

Note The diagram shows one channel inside the NI 9775.

- The shell of the BNC connects to CHASSIS GND.
- The four channels of the NI 9775 share the clock circuit and operate simultaneously.
- The NI 9775 has two separate data engines operating simultaneously for each channel: the continuous stream engine and triggered record engine.
- The module waits for a trigger event, fills the circular buffer with the configured set of data (called a record), then streams the entire record from the module to the chassis.
- The analog filter allows you to select 10 MHz or 5 MHz bandwidth.
- The software-selectable digital decimation filter improves resolution and alias rejection.
- The ADC samples the analog signal continuously at 20 MS/s.

Timing Modes

The NI 9775 has two timing modes: high-speed and high-resolution. High-speed mode turns off the digital decimation filter on all channels and enables you to set the analog filter per channel. High-resolution mode turns on both the analog filter and digital decimation filter for all channels.

Acquisition Modes

The NI 9775 has three acquisition modes: continuous mode, record mode, and advanced mode. In continuous mode, the NI 9775 transfers real-time data to the chassis at an aggregate rate of 4 MS/s across all channels. In record mode, the NI 9775 stores samples into onboard memory at up to 20 MS/s then transfers the data to the chassis at a slower rate. In advanced

mode, the NI 9775 combines the functionality of continuous mode and record mode to enable more complex triggering schemes based on the continuous data.



Note Advanced mode is only available on CompactRIO systems.

Related Information

[Horizontal](#) on page 11

NI 9775 Specifications

The following specifications are typical for the range -40 °C to 70 °C unless otherwise noted.



Caution Do not operate the NI 9775 in a manner not specified in this document. Product misuse can result in a hazard. You can compromise the safety protection built into the product if the product is damaged in any way. If the product is damaged, return it to NI for repair.

Input Characteristics

Number of channels	4 (simultaneously sampled)
Input type	Reference single-ended
Input impedance	1 M Ω
Input capacitance	24 pF
Input coupling	DC
Input range	
Nominal	± 10 V
Typical	± 11.3 V
Minimum	± 10.04 V
ADC resolution	14 bits
Overvoltage protection	± 30 V DC, safe operating area

Figure 1. Safe Operating Area

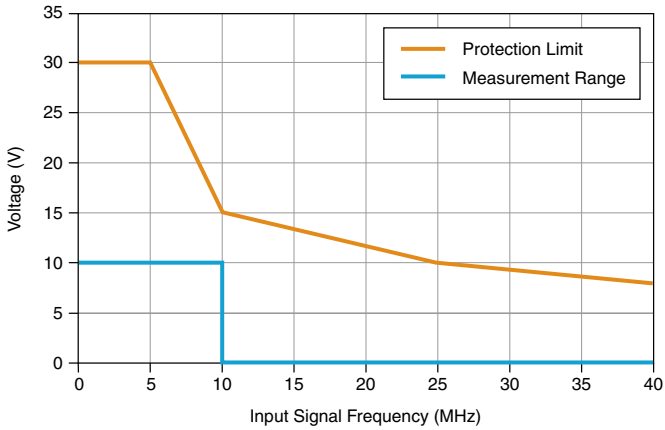

Table 1. DC Accuracy

Measurement Conditions		Percent of Reading (Gain Error)	Percent of Range ¹ (Offset Error)
Calibrated	Maximum (-40 °C to 70 °C)	±1.7%	±0.49%
	Typical (25 °C, ±5 °C)	±0.32%	±0.08%
Uncalibrated ²	Maximum (-40 °C to 70 °C)	±4.0%	±4.0%
	Typical (25 °C, ±5 °C)	±1.7%	±1.8%

DC gain drift ±140 ppm/°C

DC offset drift ±0.34 mV/°C

AC amplitude accuracy ±0.25 dB at 50 kHz

AC amplitude drift ±172 ppm/°C

Channel-to-channel crosstalk < -90 dB at 5 MHz

Timing modes (software-selectable) High-speed, high-resolution

Analog filter (software-selectable) 6th order low-pass Bessel

¹ Range equals 10 V for absolute accuracy calculations.

² Uncalibrated accuracy refers to the accuracy achieved when acquiring in raw or unscaled modes where the calibration constants stored in the module are not applied to the data.

Analog filter -3 dB bandwidth

High-speed mode with analog filter disabled	13.9 MHz
High-speed mode with analog filter enabled	4.7 MHz
High-resolution mode	2.36 MHz
Alias rejection in high-resolution mode	45 dB at 5 MS/s only

Figure 2. Frequency Response in High-Speed Mode with Analog Filter Disabled

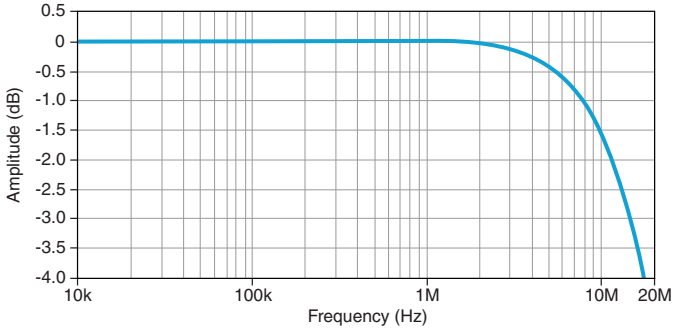

Figure 3. Frequency Response in High-Speed Mode with Analog Filter Enabled

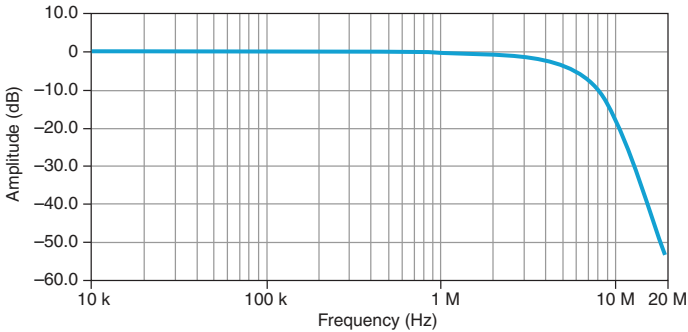

Figure 4. Frequency Response in High-Resolution Mode

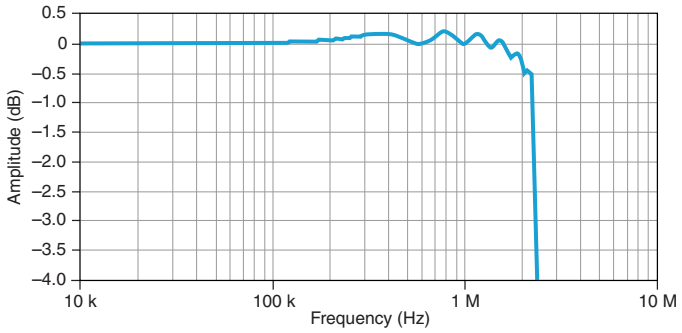

Figure 5. Idle Channel FFT in High-Speed Mode with Analog Filter Disabled (20 MS/s, 32,768 point FFT)

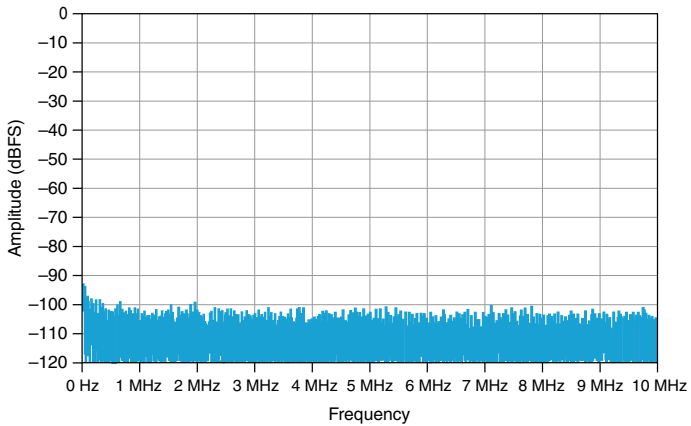

Figure 6. Idle Channel FFT in High-Resolution Mode (1 MS/s, 32,768 point FFT)

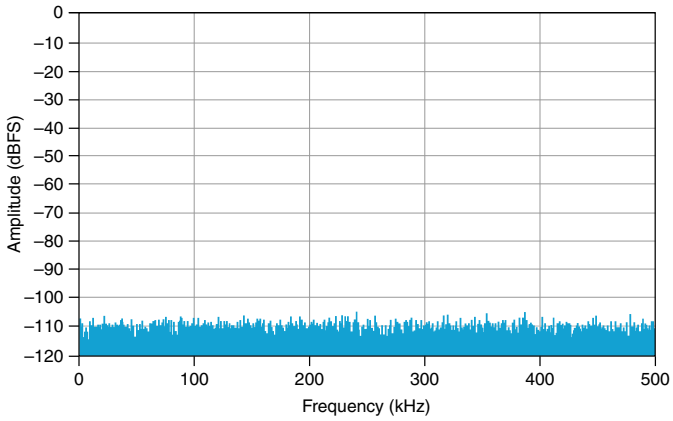

Figure 7. Step Response

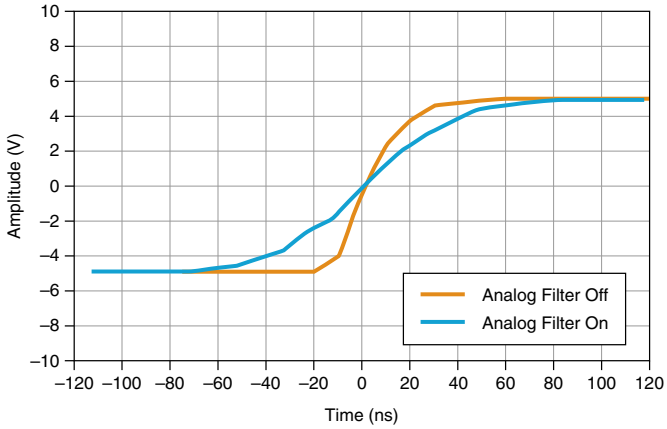
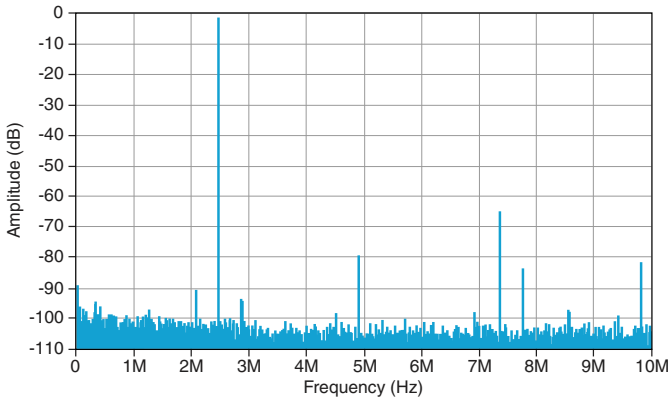

Figure 8. Single-Tone Spectrum at (-1 dB FS, 2.45 MHz)



Spurious free dynamic range (-60 dB FS input)

High-speed mode at 2.45 MHz	89 dB FS
High-resolution mode at 100 kHz	94 dB FS

Input to trigger delay

High-speed mode with analog filter disabled	863 ns
High-speed mode with analog filter enabled	950 ns
High-resolution mode	4.62 μ s

Input delay (Continuous Mode)

High-speed mode with analog filter disabled	913 ns
High-speed mode with analog filter enabled	999 ns
High-resolution mode	4.67 μ s

Noise

High-speed mode	2.8 mV RMS
High-resolution mode	1.4 mV RMS

Effective number of bits

High-speed mode	11 bits
High-resolution mode	12 bits

Signal-to-Noise ratio

High-speed mode	68 dB at 2.45 MHz
High-resolution mode	74 dB at 100 kHz

Total harmonic distortion at -1 dB FS input

High-speed mode with analog filter disabled at 2.45 MHz	-62 dB FS
High-speed mode with analog filter enabled at 1 MHz	-69 dB FS
High-resolution mode at 100 kHz and	-75 dB FS

Channel-to-channel skew

Analog filter disabled	1.5 ns
Analog filter enabled	12.7 ns

LSB weight	1.385 mV/LSB
------------	--------------

Horizontal

Sample clock source	20 MHz PLL
---------------------	------------

Maximum sample rate in record mode

High-speed mode	20 MS/s
High-resolution mode	5 MS/s

Figure 9. Phase Noise

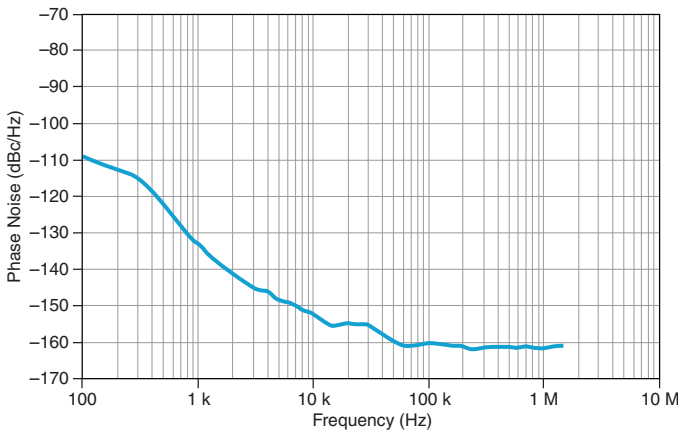

Timebase frequency	20 MHz
--------------------	--------

Timebase accuracy	±50 ppm
-------------------	---------

PLL reference clock source

Internal master timebase	12.8 MHz
Chassis OCLK	12.8 MHz

Data Rate in Record Mode

$$\frac{20 \text{ MS/s}}{N}$$

Where

$N \in \{1, 2, 3, 4, 5, \dots, 65,535\}$ for high-speed mode

$N \in \{4, 8, 12, 16, 20, \dots, 65,532\}$ for high-resolution mode

Data Rate in Continuous Mode

$$\frac{20 \text{ MS/s}}{M}$$

Where

$M \in \{5, 6, 7, 8, 9, \dots, 65,535\}$ with one channel enabled for high-speed mode

$M \in \{8, 12, 16, 20, 24, \dots, 65,532\}$ with one channel enabled for high-resolution mode

$M \in \{10, 11, 12, 13, 14, \dots, 65,535\}$ with two channels enabled for high-speed mode

$M \in \{12, 16, 20, 24, 28, \dots, 65,532\}$ with two channels enabled for high-resolution mode

$M \in \{15, 16, 17, 18, 19, \dots, 65,535\}$ with three channels enabled for high-speed mode

$M \in \{16, 20, 24, 28, 32, \dots, 65,532\}$ with three channels enabled for high-resolution mode

$M \in \{20, 21, 22, 23, 24, \dots, 65,535\}$ with four channels enabled for high-speed mode

$M \in \{20, 24, 28, 32, 36, \dots, 65,532\}$ with four channels enabled for high-resolution mode

Trigger

Supported trigger modes	Start and reference
Trigger types	Analog edge, digital edge, and software
Trigger sources	AI0 to AI3 and chassis backplane
Dead time	0 samples

Analog Edge Trigger

Trigger sources	AI0 to AI3
Settings	Level, slope, and hysteresis
Trigger uncertainty	≤ 1 sample
Rearm time	1 sample minimum

Waveform Specifications

Onboard memory size	128 Mbits
Minimum record length	16 samples
Minimum number of pre-trigger samples	
CompactRIO	1
CompactDAQ	2
Minimum number of post-trigger samples	
CompactRIO	1
CompactDAQ	2
Maximum number of records	32 records
Maximum number of samples per record ³	$2 * \left[\left(\frac{2^{22}}{\text{Number of records}} \right) - 1 \right]$ <i>Number of channels</i>
Record data transfer rate	
Maximum ⁴	4.7 MS/s
Typical	4 MS/s

Power Requirements

Power consumed from chassis	
Active mode	0.9 W maximum
Sleep mode	52.5 μW maximum
Thermal dissipation (at 70 °C)	
Active mode	1.06 W maximum
Sleep mode	3.65 mW maximum

³ The maximum number of samples per record is different for CompactRIO systems.

⁴ With all four channels enabled.

Safety Voltages

Connect only voltages that are within Measurement Category O.

Isolation

Channel-to-channel	None
Channel-to-earth ground	None



Note Measurement Categories CAT I and CAT O are equivalent. These test and measurement circuits are not intended for direct connection to the MAINS building installations of Measurement Categories CAT II, CAT III, or CAT IV.



Caution Do not connect the NI 9775 to signals or use for measurements within Measurement Categories II, III, or IV.

Physical Characteristics

If you need to clean the module, wipe it with a dry towel.



Tip For two-dimensional drawings and three-dimensional models of the C Series module and connectors, visit ni.com/dimensions and search by module number.

Weight	172 g
--------	-------

Hazardous Locations

U.S. (UL)	Class I, Division 2, Groups A, B, C, D, T4; Class I, Zone 2, AEx nA IIC T4
Canada (C-UL)	Class I, Division 2, Groups A, B, C, D, T4; Class I, Zone 2, Ex nA IIC T4
Europe (ATEX) and International (IECEX)	Ex nA IIC T4 Gc

Safety and Hazardous Locations Standards

This product is designed to meet the requirements of the following electrical equipment safety standards for measurement, control, and laboratory use:

- IEC 61010-1, EN 61010-1
- UL 61010-1, CSA 61010-1
- EN 60079-0:2012, EN 60079-15:2010
- IEC 60079-0: Ed 6, IEC 60079-15; Ed 4
- UL 60079-0; Ed 6, UL 60079-15; Ed 4
- CSA 60079-0:2011, CSA 60079-15:2012



Note For UL and other safety certifications, refer to the product label or the [Online Product Certification](#) section.

Electromagnetic Compatibility

This product meets the requirements of the following EMC standards for electrical equipment for measurement, control, and laboratory use:

- EN 61326-1 (IEC 61326-1): Class A emissions; Industrial immunity
- EN 55011 (CISPR 11): Group 1, Class A emissions
- EN 55022 (CISPR 22): Class A emissions
- EN 55024 (CISPR 24): Immunity
- AS/NZS CISPR 11: Group 1, Class A emissions
- AS/NZS CISPR 22: Class A emissions
- FCC 47 CFR Part 15B: Class A emissions
- ICES-001: Class A emissions



Note In the United States (per FCC 47 CFR), Class A equipment is intended for use in commercial, light-industrial, and heavy-industrial locations. In Europe, Canada, Australia and New Zealand (per CISPR 11) Class A equipment is intended for use only in heavy-industrial locations.



Note Group 1 equipment (per CISPR 11) is any industrial, scientific, or medical equipment that does not intentionally generate radio frequency energy for the treatment of material or inspection/analysis purposes.



Note For EMC declarations and certifications, and additional information, refer to the [Online Product Certification](#) section.

CE Compliance

This product meets the essential requirements of applicable European Directives, as follows:

- 2014/35/EU; Low-Voltage Directive (safety)
- 2014/30/EU; Electromagnetic Compatibility Directive (EMC)
- 2014/34/EU; Potentially Explosive Atmospheres (ATEX)

Online Product Certification

Refer to the product Declaration of Conformity (DoC) for additional regulatory compliance information. To obtain product certifications and the DoC for this product, visit ni.com/certification, search by model number or product line, and click the appropriate link in the Certification column.

Shock and Vibration

To meet these specifications, you must panel mount the system.

Operating vibration

Random (IEC 60068-2-64)	5 g _{rms} , 10 Hz to 500 Hz
Sinusoidal (IEC 60068-2-6)	5 g, 10 Hz to 500 Hz
Operating shock (IEC 60068-2-27)	30 g, 11 ms half sine; 50 g, 3 ms half sine; 18 shocks at 6 orientations

Environmental

Refer to the manual for the chassis you are using for more information about meeting these specifications.

Operating temperature (IEC 60068-2-1, IEC 60068-2-2)	-40 °C to 70 °C
Storage temperature (IEC 60068-2-1, IEC 60068-2-2)	-40 °C to 85 °C
Ingress protection	IP40
Operating humidity (IEC 60068-2-78)	10% RH to 90% RH, noncondensing
Storage humidity (IEC 60068-2-78)	5% RH to 95% RH, noncondensing
Pollution Degree	2
Maximum altitude	5,000 m

Indoor use only.

Environmental Management

NI is committed to designing and manufacturing products in an environmentally responsible manner. NI recognizes that eliminating certain hazardous substances from our products is beneficial to the environment and to NI customers.

For additional environmental information, refer to the *Minimize Our Environmental Impact* web page at ni.com/environment. This page contains the environmental regulations and directives with which NI complies, as well as other environmental information not included in this document.

Waste Electrical and Electronic Equipment (WEEE)



EU Customers At the end of the product life cycle, all NI products must be disposed of according to local laws and regulations. For more information about how to recycle NI products in your region, visit ni.com/environment/weee.

电子信息产品污染控制管理办法（中国 RoHS）



中国客户 National Instruments 符合中国电子信息产品中限制使用某些有害物质指令 (RoHS)。关于 National Instruments 中国 RoHS 合规性信息，请登录 ni.com/environment/rohs_china。(For information about China RoHS compliance, go to ni.com/environment/rohs_china.)

Calibration

You can obtain the calibration certificate and information about calibration services for the NI 9775 at ni.com/calibration.

Calibration interval	1 year
----------------------	--------

Information is subject to change without notice. Refer to the *NI Trademarks and Logo Guidelines* at ni.com/trademarks for information on NI trademarks. Other product and company names mentioned herein are trademarks or trade names of their respective companies. For patents covering NI products/technology, refer to the appropriate location: **Help»Patents** in your software, the `patents.txt` file on your media, or the *National Instruments Patent Notice* at ni.com/patents. You can find information about end-user license agreements (EULAs) and third-party legal notices in the readme file for your NI product. Refer to the *Export Compliance Information* at ni.com/legal/export-compliance for the NI global trade compliance policy and how to obtain relevant HTS codes, ECCNs, and other import/export data. NI MAKES NO EXPRESS OR IMPLIED WARRANTIES AS TO THE ACCURACY OF THE INFORMATION CONTAINED HEREIN AND SHALL NOT BE LIABLE FOR ANY ERRORS. U.S. Government Customers: The data contained in this manual was developed at private expense and is subject to the applicable limited rights and restricted data rights as set forth in FAR 52.227-14, DFAR 252.227-7014, and DFAR 252.227-7015.

© 2016—2017 National Instruments. All rights reserved.

377101B-02 April 10, 2017