

Current transducers - MCR-SL-S-200-U - 2813460

Please be informed that the data shown in this PDF Document is generated from our Online Catalog. Please find the complete data in the user's documentation. Our General Terms of Use for Downloads are valid (<http://phoenixcontact.com/download>)

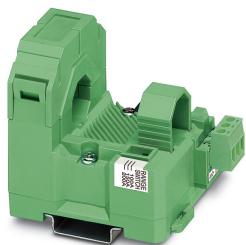

MCR current measuring transducer, for measuring sinusoidal and non-sinusoidal alternating currents, input current 0...200 A, output voltage 0...(5) 10 V

Your advantages

- Can be retrofitted with open-up Rogowski coil
- 30 ... 6000 Hz true r.m.s. value measurement
- Measuring range selection via slide switch
- Loop-powered



Key Commercial Data

Packing unit	1 pc
GTIN	 4 046356 043649
GTIN	4046356043649

Technical data

Dimensions

Width	55 mm
Height	85 mm
Depth	70.5 mm

Ambient conditions

Ambient temperature (operation)	-20 °C ... 60 °C
Degree of protection	IP20

Input data

Input	Current measuring input
Input current range	0 A ... 200 A (0 ... 100/150/200 A)
Operate threshold	1 % (of final value)
Setting range for min. input current	0 A ... 100 A

Current transducers - MCR-SL-S-200-U - 2813460

Technical data

Input data

Setting range for max. input current	0 A ... 200 A
Overload capacity	Depending on laid conductor
Surge strength	Depending on through connected conductor
Frequency measuring range	30 Hz ... 6000 Hz

Output data

Output name	Voltage output
Voltage output signal	0 V ... 10 V
	0 V ... 5 V
Max. output voltage	(0 V ... 10 V) 14 V, (0 V ... 5 V) 7 V
Load/output load voltage output	≥ 10 kΩ

Switching output

Output name	No switching output
-------------	---------------------

Power supply

Nominal supply voltage	24 V DC
Max. current consumption	< 30 mA

Connection data

Connection method	Pluggable screw connection
Stripping length	8 mm
Screw thread	M3
Conductor cross section solid	0.2 mm ² ... 2.5 mm ²
Conductor cross section flexible	0.2 mm ² ... 2.5 mm ²
Conductor cross section AWG	24 ... 14
Torque	0.5 Nm ... 0.6 Nm (4,4 ... 5,31 lbf-in.)

General

Maximum transmission error	< 1 % (of final value)
Maximum temperature coefficient	< 0.035 %/K
Step response (10-90%)	< 340 ms
Overvoltage category	III
Degree of pollution	2
Rated insulation voltage	300 V AC (to earth)
Test voltage input/output	5 kV (50 Hz, 1 min.)
Housing material	Polyamide PA non-reinforced
Mounting position	any

Conformance/approvals

Designation	CE
Certificate	CE-compliant
Designation	UL, USA / Canada
Identification	UL/C-UL Listed UL 508

Current transducers - MCR-SL-S-200-U - 2813460

Technical data

Conformance/approvals

	Class I, Div. 2, Groups A, B, C, D T4A
	Class I, Zone 2, Group IIC T4A
	Or Non-Hazardous Locations only

Environmental Product Compliance

China RoHS	Environmentally Friendly Use Period = 25;
	For details about hazardous substances go to tab "Downloads", Category "Manufacturer's declaration"

Drawings

Application drawing

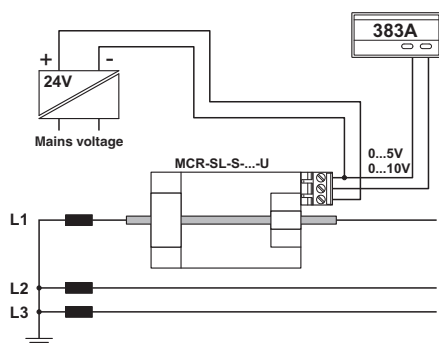

Circuit diagram

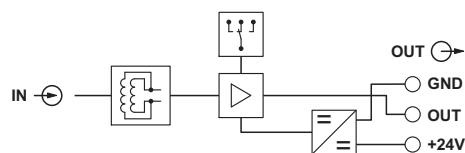

Current measurement

Dimensional drawing

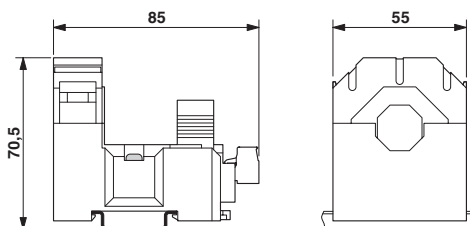

Classifications

eCl@ss

eCl@ss 10.0.1	27210123
eCl@ss 11.0	27210123
eCl@ss 4.0	27271100

Current transducers - MCR-SL-S-200-U - 2813460

Classifications

eCl@ss

eCl@ss 4.1	27200300
eCl@ss 5.0	27200300
eCl@ss 5.1	27200300
eCl@ss 6.0	27210100
eCl@ss 7.0	27210123
eCl@ss 9.0	27210123

ETIM

ETIM 3.0	EC002475
ETIM 4.0	EC002475
ETIM 6.0	EC002475
ETIM 7.0	EC002475

UNSPSC

UNSPSC 6.01	30211506
UNSPSC 7.0901	39121008
UNSPSC 11	39121008
UNSPSC 12.01	39121008
UNSPSC 13.2	39121032
UNSPSC 18.0	39121032
UNSPSC 19.0	39121032
UNSPSC 20.0	39121032
UNSPSC 21.0	39121032

Approvals

Approvals

Approvals

UL Listed / cUL Listed / EAC / cULus Listed

Ex Approvals

Approval details

UL Listed		http://database.ul.com/cgi-bin/XYV/template/LISEXT/1FRAME/index.htm	FILE E 123528
-----------	--	---	---------------

Current transducers - MCR-SL-S-200-U - 2813460

Approvals

cUL Listed		http://database.ul.com/cgi-bin/XYV/template/LISEXT/1FRAME/index.htm	FILE E 123528
------------	---	---	---------------

EAC		RU*DE.*08.B.01852-19
-----	---	----------------------

cULus Listed	
--------------	---

Phoenix Contact 2021 © - all rights reserved
<http://www.phoenixcontact.com>

PHOENIX CONTACT GmbH & Co. KG
Flachsmarktstr. 8
32825 Blomberg
Germany
Tel. +49 5235 300
Fax +49 5235 3 41200
<http://www.phoenixcontact.com>