

KEG/ZL ball bearing

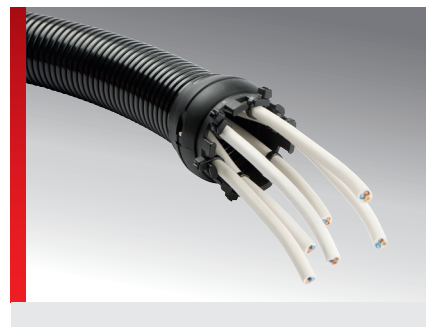

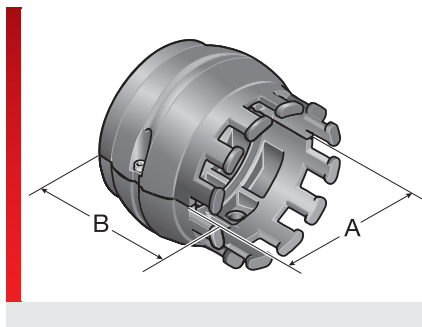

PRODUCT INFORMATION





The KEG-ZL is used wherever cords or cables exit from the cable protection conduit with strain relief.

The detachably connected type KEG-ZL ball joint with integrated strain relief can easily and quickly be placed into the SH system holder and thus connected to the Murrflex

cable protection conduits and the robot. The cords, conduits and cables are connected to the integrated strain relief with cable ties.

SPECIFICATIONS

-  Mod. polyamide
-  -40 – 110 °C
-  V0

 HF
 RoHS

 Made in Germany

Type	Order No.	Colour	Suitable for Murrflex	Suitable for System holder	Version	A mm	B mm	Pack qty.
KEG/ZL-M25	83692258	Black	M25/P21	SH-P / M25-M32	separable	42.50	38.50	1
KEG/ZL-M32	83692260	Black	M32/P29	SH-P / M25-M32	separable	42.50	38.50	1
KEG/ZL-M40	83692262	Black	M40/P36	SH-P / M40-M50	separable	69.00	56.50	1
KEG/ZL-M50	83692264	Black	M50/P48	SH-P / M40-M50	separable	69.00	56.50	1

 Mod. polyamide

THERMAL PROPERTIES

 Temperature / temperature range
-40 – 110 °C

FIRE BEHAVIOUR

 Fire classification
V0

TECHNICAL INFORMATION

 Halogen-free

CONFORMITY

 RoHS (EC Directive 2011/65/EU)

KEG/ZL ball bearing

APPROVALS AND OPERATING PERMITS



ROBI approval



Made in Germany

All details given in our sales material prospectuses and catalogues as well as the information available online are based on our current knowledge of the products described.

The electronic data and files made available by Murrplastik, particularly CAD files are based on our current knowledge of the product described.

A legally binding assurance of certain properties or the suitability for a certain purpose can not be determined from this information.

All information with respect to the chemical and physical properties of Murrplastik products as well as application advice given verbally, in writing or by tests, is given to the best of our knowledge.

This does not free the purchaser of carrying out their own inspections and tests in order to determine the suitability of a product for a specific purpose.

Murrplastik accepts no responsibility for the available information being up-to-date, correct or complete. Neither do we accept responsibility for the quality of this information.

Murrplastik accepts no liability for damage caused as a result of using our products.

Murrplastik reserves the right to make technical changes and improvements through constant further development of products and services.

Our General Terms and Conditions apply.