

Sensor/actuator box - SACB-4/ 4-L-10,0PUR SCO P - 1452589

Please be informed that the data shown in this PDF Document is generated from our Online Catalog. Please find the complete data in the user's documentation. Our General Terms of Use for Downloads are valid (<http://phoenixcontact.com/download>)



Sensor/actuator box, application: Standard, connection method: M12-SPEEDCON-socket Plastic, number of slots: 4, number of positions: 4, coding: A-coded, slot assignment: single, status display: yes, pnp; master cable connection: Fixed connection 180°, PUR/PVC, cable length: 10 m, shielding: no

Your advantages

- ✓ Safety in the field, thanks to molded housing and high degree of protection
- ✓ Convenient: increased machine availability thanks to quick and easy diagnostics
- ✓ Save time, thanks to installation with SPEEDCON fast locking system



Key Commercial Data

Packing unit	1 pc
GTIN	 4 046356 553919
GTIN	4046356553919

Technical data

General

Rated voltage	24 V DC
Max. operating voltage U_{max}	30 V DC
Current carrying capacity per I/O signal	2 A
Current carrying capacity per slot	4 A
Total rated current	12 A
Number of positions	4
Number of slots	4
Flammability rating according to UL 94	V0
Sensor/actuator connection system	M12-SPEEDCON-socket
Note	NOTE: Observe the permissible bending radii when laying conductors, since the degree of protection may be put in jeopardy if the bending forces are too high. Alleviate mechanical loads upstream of the connector, e.g. by using cable ties.

Sensor/actuator box - SACB-4/ 4-L-10,0PUR SCO P - 1452589

Technical data

General

	Unused slots are to be sealed off prior to commissioning. Suitable sealing elements are to be found under "Accessories".
--	--

Ambient conditions

Degree of protection	IP65
	IP67
Ambient temperature (operation)	-25 °C ... 80 °C
	-40 °C ... 90 °C (for fixed installation)
	-5 °C ... 80 °C (for flexible installation)

Local diagnostics function

Local diagnostics	Supply voltage Green LED
	Status display I/O Yellow LED

Master cable connection data

Connection method	Fixed connection
Length of cable	10 m
Tightening torque slot sensor/actuator cable	0.4 Nm
Tightening torque of mounting screw for fixing the housing	0.5 Nm

Insulation material

Housing material	PBT
Material of the moulding mass	PUR
Contact material	Cu alloy
Contact surface material	gold-plated
Contact carrier material	PA
Material of threaded sleeve	PBT
O-ring material	NBR

Pin assignment

Slot/position = Wire color or connection	1 / 4 (A) = WH
	2 / 4 (A) = GN
	3 / 4 (A) = YE
	4 / 4 (A) = GY
	1-4 / 1 (+ 24 V) = BN
	1-4 / 3 (0 V) = BU
	1-4 / 5 (PE) = GN/YE

Standards and Regulations

Standards/specifications	M12 connector IEC 61076-2-101
--------------------------	-------------------------------

Cable

Cable type	PUR/PVC black
Cable type (abbreviation)	PUR
Cable abbreviation	LiYY11Y-HF

Sensor/actuator box - SACB-4/ 4-L-10,0PUR SCO P - 1452589

Technical data

Cable

UL AWM style	20549
Conductor cross section	4x 0.34 mm ² (Signal line)
	3x 0.75 mm ² (power line)
AWG signal line	22
AWG power supply	18
Conductor structure signal line	19x 0.15 mm
Conductor structure, voltage supply	42x 0.15 mm
Core diameter including insulation	1.3 mm ±0.1 mm (Signal line)
	1.8 mm ±0.1 mm (power line)
Wire colors	brown, blue, green/yellow, white, green, yellow, gray
Overall twist	Wires twisted in layers
Inner sheath thickness	≥ 0.15 mm
Outer sheath thickness	≥ 0.38 mm
External cable diameter D	6.9 mm ±0.2 mm
Minimum bending radius, fixed installation	7.5 x D
Minimum bending radius, flexible installation	10 x D
Number of bending cycles	1500000
Bending radius	69 mm
Traversing path	2 m
Traversing rate	2 m/s
Cable weight	77.9 kg/km
External sheath, color	black RAL 9005
Outer sheath, material	PUR
Material, inner sheath	PVC
Material conductor insulation	PVC
Conductor material	Bare Cu litz wires
Nominal voltage, cable	300 V
Test voltage, cable	2000 V
Special properties	Silicone-free
Other resistance	Highly resistant to acids, alkaline solutions and solvents
Flame resistance	DIN EN 50265
Resistance to oil	according to VDE 0472 Part 803
Ambient temperature (operation)	-40 °C ... 90 °C (cable, fixed installation)
	-5 °C ... 80 °C (Cable, flexible installation)

Environmental Product Compliance

China RoHS	Environmentally friendly use period: unlimited = EFUP-e
	No hazardous substances above threshold values

Drawings

Sensor/actuator box - SACB-4/ 4-L-10,0PUR SCO P - 1452589

Schematic diagram

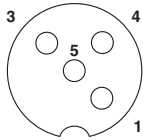

M12 slot, socket, 4-pos.

Circuit diagram

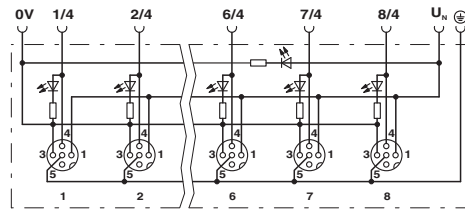

Dimensional drawing

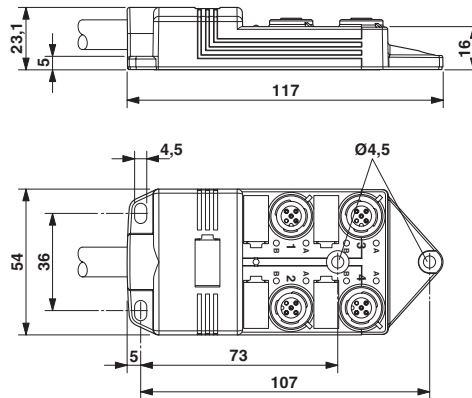

Sensor/actuator box - SACB-4/ 4-L-10,0PUR SCO P - 1452589

Cable cross section

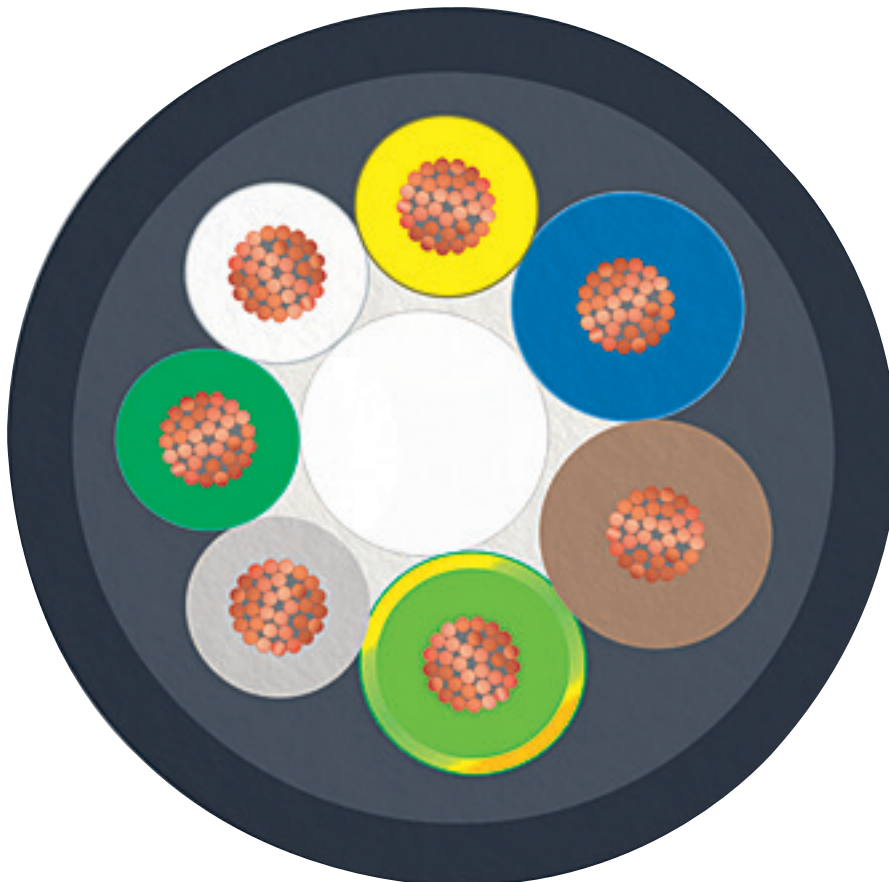

PUR/PVC black [PUR]

Classifications

eCl@ss

eCl@ss 10.0.1	27440108
eCl@ss 11.0	27440108
eCl@ss 4.0	27140800
eCl@ss 4.1	27140800
eCl@ss 5.0	27143400
eCl@ss 5.1	27250300
eCl@ss 6.0	27279200
eCl@ss 7.0	27279219
eCl@ss 9.0	27440108

ETIM

ETIM 4.0	EC002585
----------	----------

Sensor/actuator box - SACB-4/ 4-L-10,0PUR SCO P - 1452589

Classifications

ETIM

ETIM 6.0	EC002585
ETIM 7.0	EC002585

UNSPSC

UNSPSC 6.01	31261501
UNSPSC 7.0901	31261501
UNSPSC 11	31261501
UNSPSC 12.01	31261501
UNSPSC 13.2	31251501
UNSPSC 19.0	31251501
UNSPSC 20.0	31251501
UNSPSC 21.0	31251501

Approvals

Approvals

Approvals

UL Recognized / cUL Recognized / EAC / EAC / cULus Recognized

Ex Approvals

Approval details

UL Recognized		http://database.ul.com/cgi-bin/XYV/template/LISEXT/1FRAME/index.htm	FILE E 118976
Nominal voltage UN		24 V	
Nominal current IN		4 A	

cUL Recognized		http://database.ul.com/cgi-bin/XYV/template/LISEXT/1FRAME/index.htm	FILE E 118976
Nominal voltage UN		24 V	

EAC		RU C- DE.BL08.B.00286
-----	--	--------------------------

Sensor/actuator box - SACB-4/ 4-L-10,0PUR SCO P - 1452589

Approvals

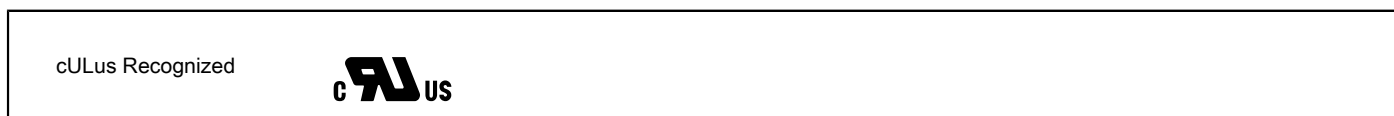
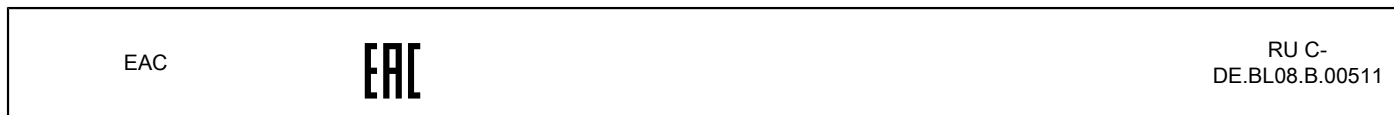

Accessories

Accessories

Device marking

Snap-in markers - UC-EM (17,5X9) - 0827490



Snap-in markers, Sheet, white, unlabeled, can be labeled with: BLUEMARK ID, BLUEMARK ID COLOR, BLUEMARK CLED, BLUEMARK LED, CMS-P1-PLOTTER, PLOTMARK, mounting type: snapped, lettering field size: 17.5 x 9 mm, Number of individual labels: 20

Snap-in markers - UCT-EM (17,5X9) - 0801491



Snap-in markers, Sheet, white, unlabeled, can be labeled with: TOPMARK NEO, TOPMARK LASER, BLUEMARK ID COLOR, BLUEMARK ID, BLUEMARK CLED, THERMOMARK PRIME, THERMOMARK CARD 2.0, THERMOMARK CARD, mounting type: snapped, lettering field size: 17.5 x 9 mm, Number of individual labels: 24

Snap-in markers - UC-EM (17,5X9) YE - 0827494



Snap-in markers, Sheet, yellow, unlabeled, can be labeled with: BLUEMARK ID COLOR, BLUEMARK ID, BLUEMARK CLED, PLOTMARK, CMS-P1-PLOTTER, mounting type: snapped, lettering field size: 17.5 x 9 mm, Number of individual labels: 20

Snap-in markers - UCT-EM (17,5X9) YE - 0801492



Snap-in markers, Sheet, yellow, unlabeled, can be labeled with: TOPMARK NEO, TOPMARK LASER, BLUEMARK ID COLOR, BLUEMARK ID, BLUEMARK CLED, THERMOMARK PRIME, THERMOMARK CARD 2.0, THERMOMARK CARD, mounting type: snapped, lettering field size: 17.5 x 9 mm, Number of individual labels: 24

Sensor/actuator box - SACB-4/ 4-L-10,0PUR SCO P - 1452589

Accessories

Labeled device marker

Snap-in markers - UC-EM (17,5X9) CUS - 0828238



Snap-in markers, can be ordered: by sheet, white, labeled according to customer specifications, mounting type: snapped into marker carrier, lettering field size: 17.5 x 9 mm, Number of individual labels: 20

Snap-in markers - UCT-EM (17,5X9) CUS - 0801575



UniCard sheet, for labeling devices from other manufacturers, for overview table see download area, labeled according to customer specifications

Snap-in markers - UC-EM (17,5X9) YE CUS - 0828239



Snap-in markers, can be ordered: by sheet, yellow, labeled according to customer specifications, mounting type: snapped into marker carrier, lettering field size: 17.5 x 9 mm, Number of individual labels: 20

Snap-in markers - UCT-EM (17,5X9) YE CUS - 0801576



UniCard sheet, for labeling devices from other manufacturers, for overview table see download area, labeled according to customer specifications

Mounting rail adapter

DIN rail adapter - UTA 107 - 2853983

Universal DIN rail adapter, for screwing on switchgear



Plug for cable screw gland

Sensor/actuator box - SACB-4/ 4-L-10,0PUR SCO P - 1452589

Accessories

Screw plug - PROT-MS SCO - 1553129



M12 screw plug with fast-locking system for unoccupied M12 female connectors of sensor/actuator cables, boxes, and flush-type connectors

Screwdriver tools

Adapter insert - TSD-M SAC-BIT ADAPTER - 1212600



Adapter bit for TSD-M...torque tools, E6.3-1/4" drive with 4 mm hexagon to accommodate SAC bits

Tool - SAC BIT M12-D15 - 1208432



Nut for assembling sensor/actuator cables with M12 connector and M12 connectors for assembly, with a knurl diameter of 15 mm, for 4 mm hexagonal drive

Tool - SACC BIT M12-D20 - 1208445



Nut for assembling M12 connectors for assembly with a knurl diameter of 20 mm, for 4 mm hexagonal drive

Torque tool

Torque screwdriver - TSD 04 SAC - 1208429



Torque screwdriver, with preset torque of 0.4 Nm and 4 mm hexagonal drive for M12 connectors

Sensor/actuator box - SACB-4/ 4-L-10,0PUR SCO P - 1452589

Accessories

Torque screwdriver - TSD-M 1,2NM - 1212224



Torque screw driver, accuracy as per EN ISO 6789 standard, adjustable from 0.3 - 1.2 Nm

Phoenix Contact 2022 © - all rights reserved
<http://www.phoenixcontact.com>

PHOENIX CONTACT GmbH & Co. KG
Flachsmarktstr. 8
32825 Blomberg
Germany
Tel. +49 5235 300
Fax +49 5235 3 41200
<http://www.phoenixcontact.com>