

## Distributor - SAC-ASI-J-Y-B-PUR-1,0-FS SCO - 1407575

Please be informed that the data shown in this PDF Document is generated from our Online Catalog. Please find the complete data in the user's documentation. Our General Terms of Use for Downloads are valid (<http://phoenixcontact.com/download>)



AS-Interface distributor with a high degree of protection, for a branch from two flat-ribbon conductors to a 1.0 m PUR round cable with straight M12-SPEEDCON socket



### Key Commercial Data

Packing unit	1 pc
GTIN	 4 046356 779951
GTIN	4046356779951

### Technical data

#### Dimensions

Length of cable	1 m
-----------------	-----

#### Ambient conditions

Degree of protection	IP65
	IP67
Ambient temperature (operation)	-25 °C ... 75 °C
	-25 °C ... 80 °C (Cable, flexible installation)
	-40 °C ... 80 °C (cable, fixed installation)
Ambient temperature (storage/transport)	-25 °C ... 85 °C

#### General data

Rated current at 40°C	4 A
Rated voltage	≤ 32 V DC
Number of positions	4
Standards/regulations	M12 connector IEC 61076-2-101
Overvoltage category	II
Degree of pollution	3
Connection method	AS-i penetration technique

# Distributor - SAC-ASI-J-Y-B-PUR-1,0-FS SCO - 1407575

## Technical data

### Characteristics head 1

Head type	Load center lateral AS-i Screw locking
No. of positions (pin connector pattern)	4
Material (component)	CuSn (Contact)
	Ni/Au (Contact surface)
	PBT (Contact carriers)
	PBT (Housing)
	Stainless steel (Screw connection)
Torque	1.65 Nm (Locking screw)

### Characteristics head 2

Head type	Socket straight M12 SPEEDCON
No. of positions (pin connector pattern)	4 (5)
Material (component)	CuSn (Contact)
	Ni/Au (Contact surface)
	TPU GF (Contact carriers)
	TPU (Grip)
	Zinc die-cast, nickel-plated (Screw connection)
Insertion/withdrawal cycles	≥ 100
Torque	0.4 Nm

### Standards and Regulations

Standards/specifications	M12 connector IEC 61076-2-101
--------------------------	-------------------------------

### Cable

Cable type	PUR halogen-free black
Cable type (abbreviation)	PUR
UL AWM style	20549 / 10493
Conductor cross section	4x 0.34 mm <sup>2</sup> (Signal line)
AWG signal line	22
Conductor structure signal line	42x 0.10 mm
Core diameter including insulation	1.25 mm ±0.05 mm
Wire colors	brown, white, blue, black
Overall twist	4 wires, twisted
External sheath, color	black
External cable diameter D	4.3 mm ±0.2 mm
Outer sheath, material	PUR
Material conductor insulation	PP
Conductor material	Bare Cu litz wires
Ambient temperature (operation)	-40 °C ... 80 °C (fixed routing)
	-25 °C ... 80 °C (Flexibly installed)
Ambient temperature (storage/transport)	-40 °C ... 85 °C
Shielded	no

# Distributor - SAC-ASI-J-Y-B-PUR-1,0-FS SCO - 1407575

## Technical data

### Environmental Product Compliance

REACH SVHC	Lead 7439-92-1
China RoHS	Environmentally Friendly Use Period = 50 years
	For details about hazardous substances go to tab "Downloads", Category "Manufacturer's declaration"

## Drawings

Dimensional drawing

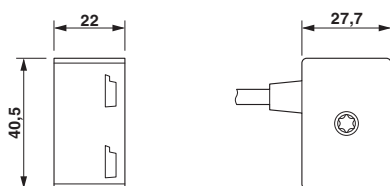

Distributor, AS-Interface

Dimensional drawing

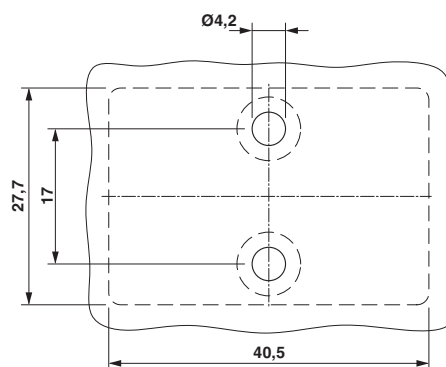

Distance and position of the mounting holes

Circuit diagram

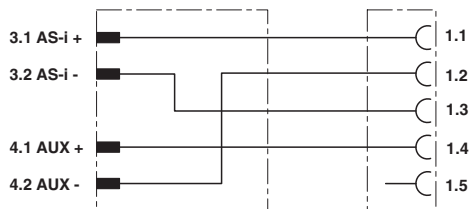

Contact assignment of the AS-Interface distributor

Dimensional drawing

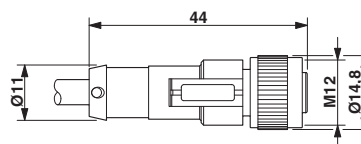

M12 x 1 socket, straight

# Distributor - SAC-ASI-J-Y-B-PUR-1,0-FS SCO - 1407575

Schematic diagram

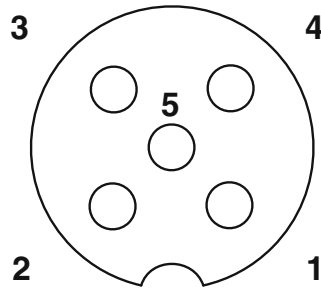

Pin assignment M12, PIN 1: AS-i +, PIN 2: AUX -, PIN 3: AS-i -, PIN 4: AUX +, PIN 5: Not used

Cable cross section

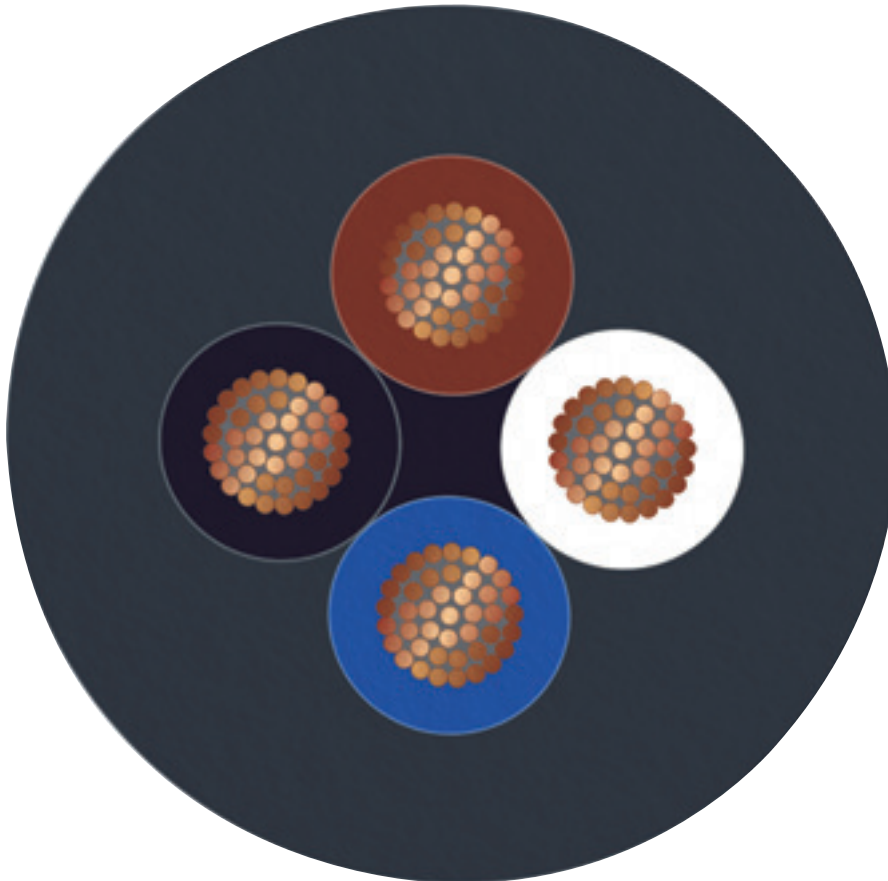

PUR halogen-free black [PUR]

## Classifications

eCl@ss

eCl@ss 10.0.1	27440106
---------------	----------

## Distributor - SAC-ASI-J-Y-B-PUR-1,0-FS SCO - 1407575

### Classifications

#### eCl@ss

eCl@ss 11.0	27440106
eCl@ss 4.0	27060300
eCl@ss 4.1	27060300
eCl@ss 5.0	27061800
eCl@ss 5.1	27061800
eCl@ss 6.0	27279200
eCl@ss 7.0	27279218
eCl@ss 9.0	27440106

#### ETIM

ETIM 3.0	EC000516
ETIM 4.0	EC001855
ETIM 6.0	EC002925
ETIM 7.0	EC002925

#### UNSPSC

UNSPSC 6.01	31261501
UNSPSC 7.0901	31261501
UNSPSC 11	31261501
UNSPSC 12.01	31261501
UNSPSC 13.2	31251501
UNSPSC 19.0	31251501
UNSPSC 20.0	31251501
UNSPSC 21.0	31251501

### Accessories

#### Accessories

##### Plug for cable screw gland

Screw plug - PROT-MS SCO - 1553129



M12 screw plug with fast-locking system for unoccupied M12 female connectors of sensor/actuator cables, boxes, and flush-type connectors

#### Screwdriver tools

## Distributor - SAC-ASI-J-Y-B-PUR-1,0-FS SCO - 1407575

### Accessories

Screwdriver - SZK PH2 VDE - 1205163



Screwdriver, PH crosshead, VDE insulated, size: PH 2 x 100 mm, 2-component grip, with non-slip grip

---

Tool - SAC BIT M12-D15 - 1208432



Nut for assembling sensor/actuator cables with M12 connector and M12 connectors for assembly, with a knurl diameter of 15 mm, for 4 mm hexagonal drive

---

### Torque tool

Torque screwdriver - TSD 04 SAC - 1208429



Torque screwdriver, with preset torque of 0.4 Nm and 4 mm hexagonal drive for M12 connectors

---

Phoenix Contact 2021 © - all rights reserved  
<http://www.phoenixcontact.com>

PHOENIX CONTACT GmbH & Co. KG  
Flachsmarktstr. 8  
32825 Blomberg  
Germany  
Tel. +49 5235 300  
Fax +49 5235 3 41200  
<http://www.phoenixcontact.com>